

UNDERGROUND PRODUCTS/VERTICAL LOCK SPACER SYSTEM DATA SHEET AND DIMENSIONS

98-1 6" CAP STRAP (100 PCS. PER CTN., WGHT. PER CTN. 7 LBS.)

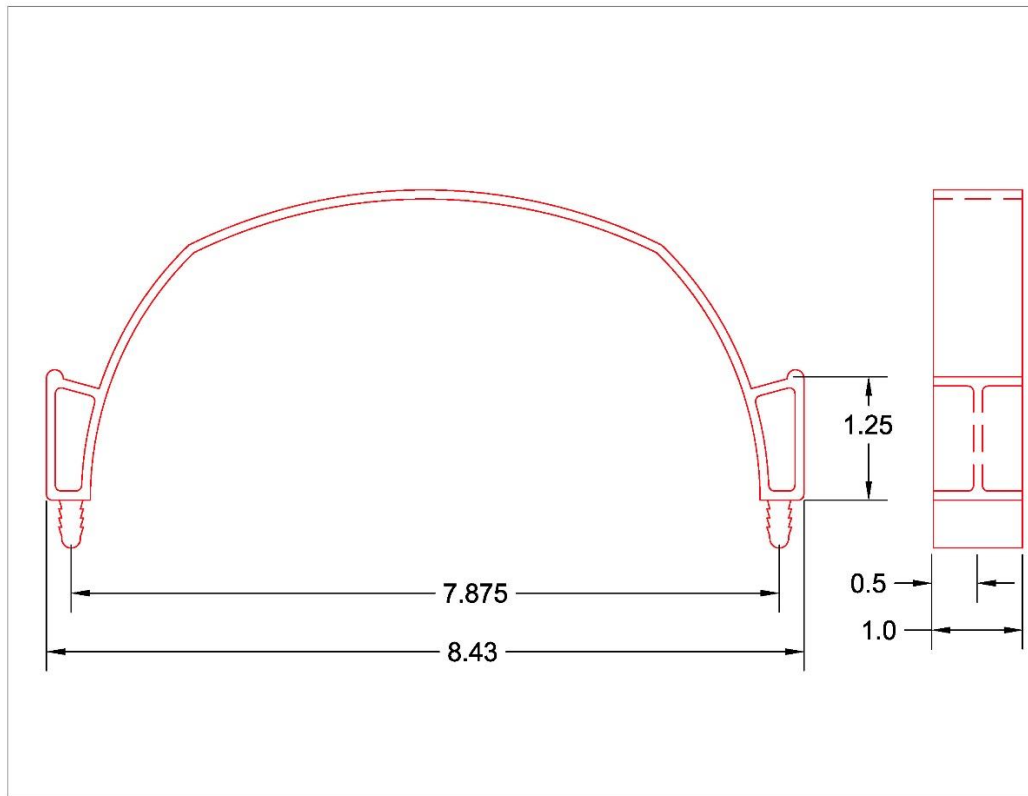

- Cap Straps offer a sturdy lock down for your intermediate spacers and assist in preventing floating of your top row of pipe
The 98-1, 6" Cap Strap fits all 6" spacers. Contact us for details and for special assembly projects.