

UNDERGROUND PRODUCTS/VERTICAL LOCK SPACER SYSTEM DATA SHEET AND DIMENSIONS

95-1 3" CAP STRAP (200 PCS. PER CTN., WGHT. PER CTN. 9 LBS.)

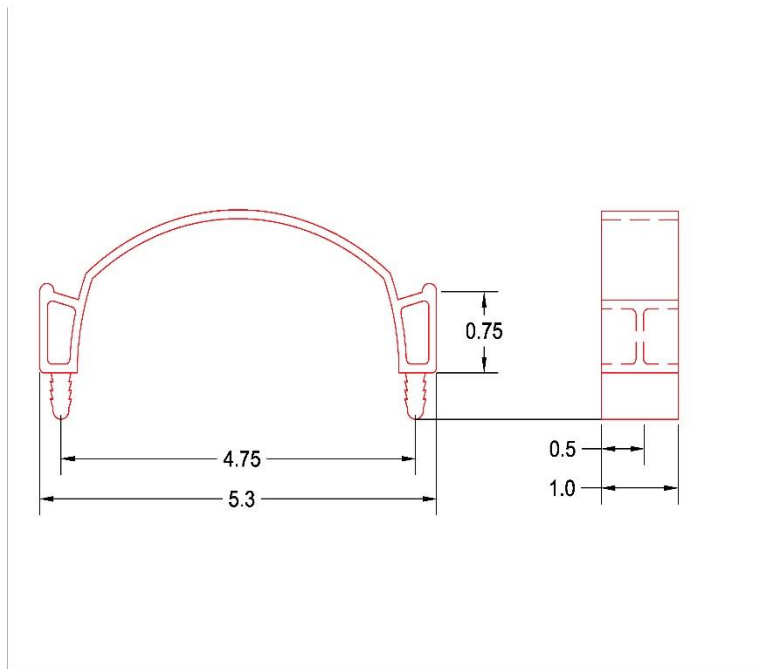

- Cap Straps offer a sturdy lock down for your intermediate spacers and assist in preventing floating of your top row of pipe
The 95-1, 3" Cap Strap fits all 3" spacers. Contact us for details and for special assembly projects.