

UNDERGROUND PRODUCTS/VERTICAL LOCK SPACER SYSTEM DATA SHEET AND DIMENSIONS

201-1 8 X 3 BASE SPACER (STD.PK. 50/CTN., WGHT. 29 LBS)

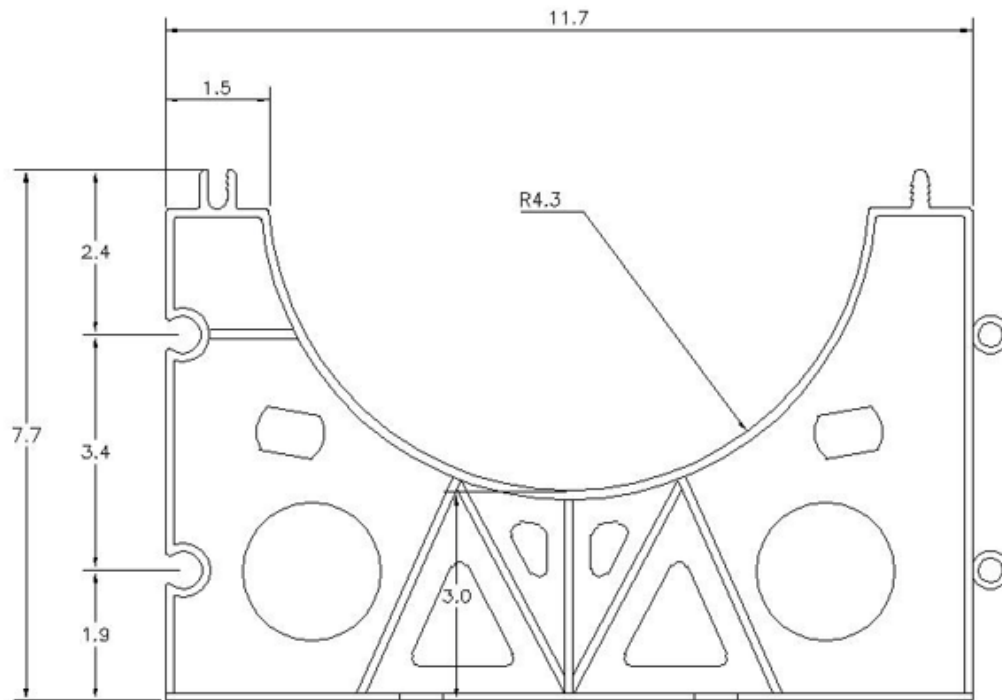

- See the Multiple Assembly Data Sheet (http://gsib.com/documents/ug_multiple_data.pdf)
For pre-assembled spacers (201-2,201-3,201-4,). Contact us for details and for special assembly projects.