

UNDERGROUND PRODUCTS/VERTICAL LOCK SPACER SYSTEM DATA SHEET AND DIMENSIONS

198-1 8 X 2 INTERMEDIATE SPACER (STD.PK.60/CTN., WGHT. 26LBS)

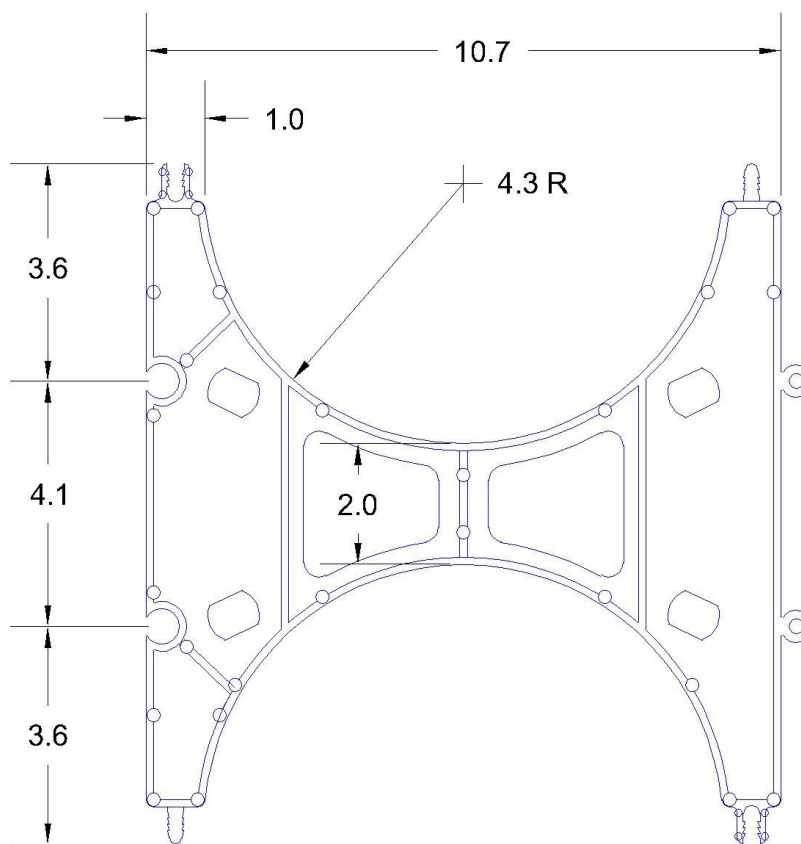

- See the Multiple Assembly Data Sheet (http://gsib.com/documents/ug_multiple_data.pdf)
For pre-assembled spacers (198-2,198-3,198-4,). Contact us for details and for special assembly projects.