

## UNDERGROUND PRODUCTS/VERTICAL LOCK SPACER SYSTEM DATA SHEET AND DIMENSIONS

185-4 4 X 1 ½ X 4 WAY INTERMEDIATE SPACER (STD.PK. 35/CTN., WGHT. 28 LBS)

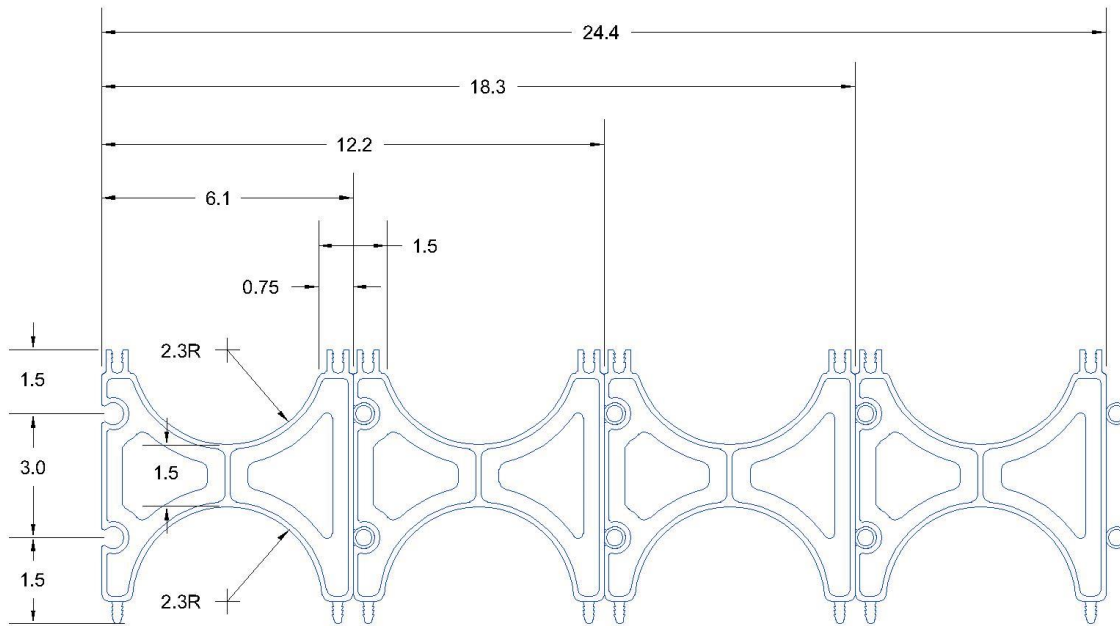

- See the Multiple Assembly Data Sheet ([http://gsib.com/documents/ug\\_multiple\\_data.pdf](http://gsib.com/documents/ug_multiple_data.pdf))  
For pre-assembled spacers (185-2,185-3,185-4,). Contact us for details and for special assembly projects.