

UNDERGROUND PRODUCTS/VERTICAL LOCK SPACER SYSTEM DATA SHEET AND DIMENSIONS

163-1 6 X 3 BASE SPACER (STD.PK. 95/CTN., WGHT. 33 LBS)

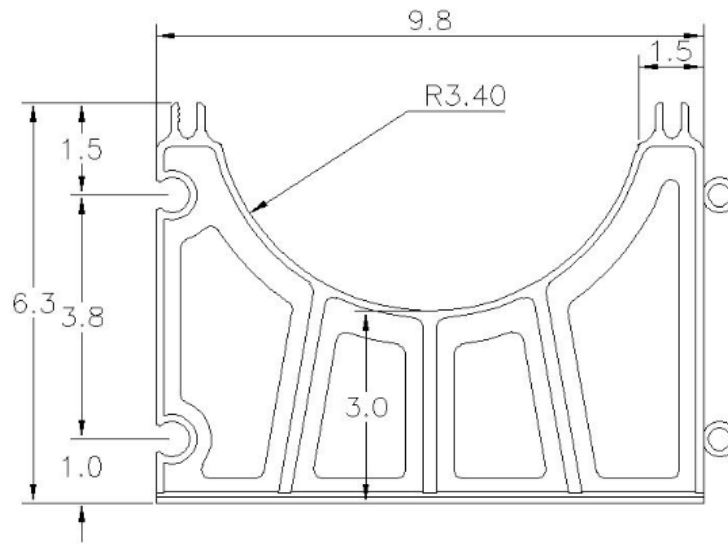

- See the Multiple Assembly Data Sheet (http://gsib.com/documents/ug_multiple_data.pdf)
For pre-assembled spacers (163-2,163-3,163-4,). Contact us for details and for special assembly projects.