

UNDERGROUND PRODUCTS/VERTICAL LOCK SPACER SYSTEM DATA SHEET AND DIMENSIONS

162-1 6X3 INTERMEDIATE SPACER (STD.PK. 70/CTN., WGHT. 22 LBS)

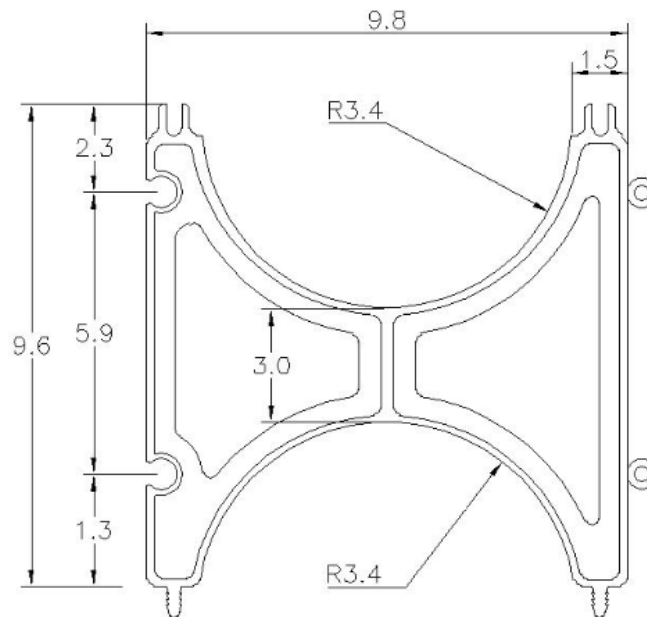

- See the Multiple Assembly Data Sheet (http://gsib.com/documents/ug_multiple_data.pdf)
For pre-assembled spacers (162-2, 162-3, 162-4,). Contact us for details and for special assembly projects.