

UNDERGROUND PRODUCTS/VERTICAL LOCK SPACER SYSTEM DATA SHEET AND DIMENSIONS

159-1 3 X 2 BASE SPACER (STD.PK. 155/CTN., WGHT. 26 LBS)

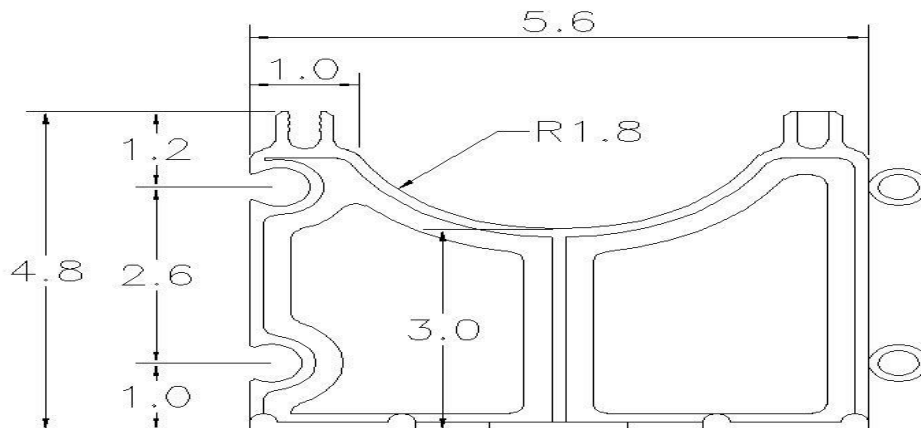

- See the Multiple Assembly Data Sheet (http://gsib.com/documents/ug_multiple_data.pdf)
For pre-assembled spacers (159-2,159-3,159-4,). Contact us for details and for special assembly projects.