

UNDERGROUND PRODUCTS/VERTICAL LOCK SPACER SYSTEM DATA SHEET AND DIMENSIONS

134-1 6X2 INTERMEDIATE SPACER (STD.PK. 90/CTN., WGHT. 35 LBS)

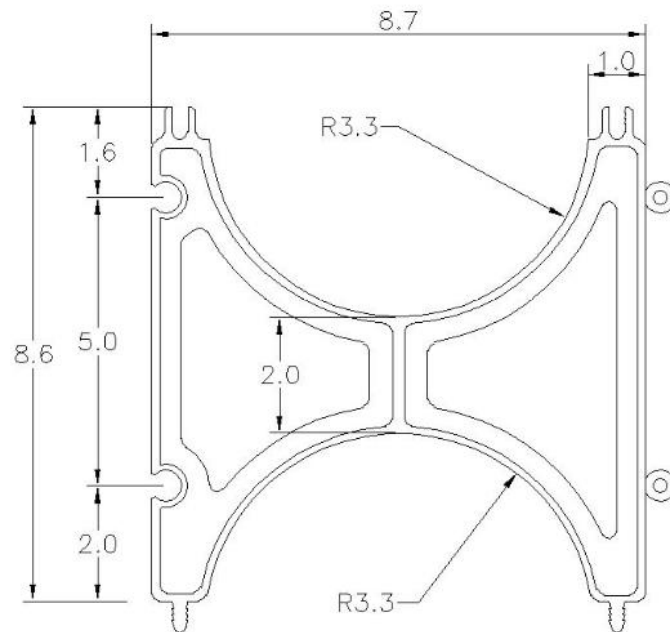

- See the Multiple Assembly Data Sheet (http://gsib.com/documents/ug_multiple_data.pdf)
For pre-assembled spacers (134-2, 134-3, 134-4,). Contact us for details and for special assembly projects.